

7842 WD

REVISIONS

ISSUE	DATE	AUTH. NO.
1	12-6-66	17356-R

- NOTES
1. WIRING LEGEND:  
 DISTANT TERMINATING AREA  
 DISTANT TERMINATING DESIGNATION  
 9-12-BL  
 WIRE COLOR CODE
  2. STRAP WITH 38522RM WIRE.
  3. ASSOCIATED CABLES:  
 164978 DISTRIBUTOR BLOCK CABLE ASSEMBLY,  
 305989 CABINET CABLE ASSEMBLY
  4. ASSOCIATED SCHEMATIC WIRING DIAGRAM:  
 76394D
  5. 263M CLUTCH MAGNET COIL OPERATES ON 0.050 AMP.
  6. COLOR CODE:  
 BK - BLACK      G - GREEN  
 BR - BROWN    BL - BLUE  
 R - RED          P - PURPLE  
 O - ORANGE    S - SLATE  
 Y - YELLOW     W - WHITE
  7. TERMINAL DESIGNATIONS ENCLOSED IN PARENTHESES ARE FOR REFERENCE AND ARE NOT HARDED ON COMPONENTS.
  8. TAPE AND TIE BACK THESE LEADS.
  9. MOUNT NETWORK ABOVE UPPER SURFACE OF DISTRIBUTOR BLOCK.
  10. CAUTION: GOLD PLATED SIGNAL LINE CONTACTS WILL BE DAMAGED UNLESS SPECIAL TEST PROCEDURES ARE FOLLOWED. REFER TO APPLICABLE BULLETIN OR SPECIFICATION.
  11. REFERENCE SPEC. FOR TELETYPE CORPORATION EMPLOYEES ONLY: 6L0726
  12.  INDICATES SHIELDED CABLE

AA  
CLUTCH MAGNET

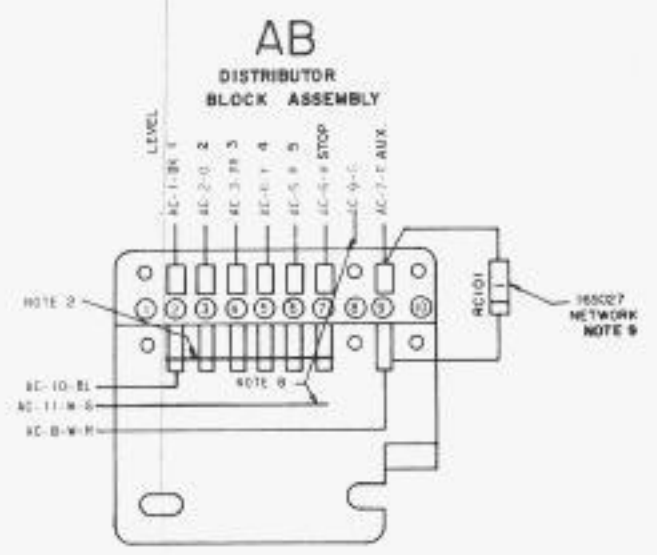
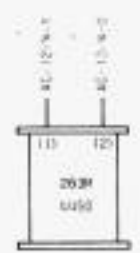

AC  
161526  
CONNECTOR RECEPTACLE

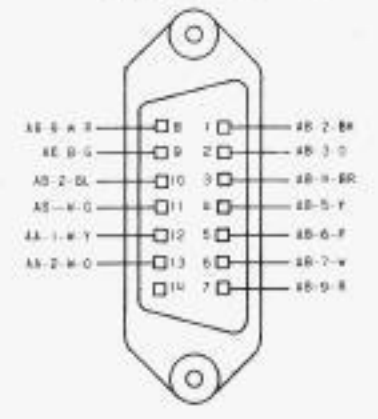

C  
CABINET TERMINAL BLOCK

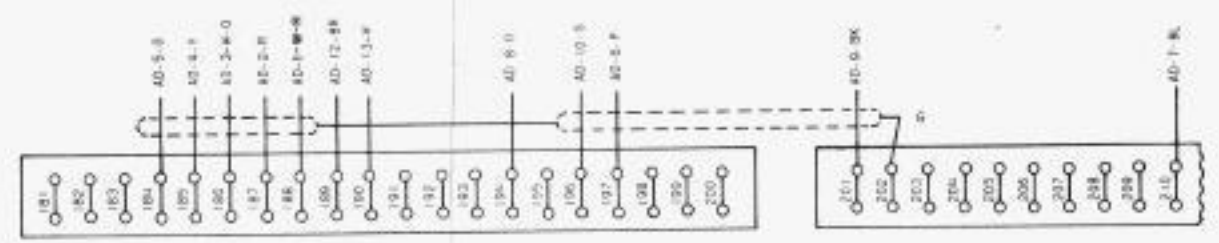

AD  
161525  
CONNECTOR PLUS

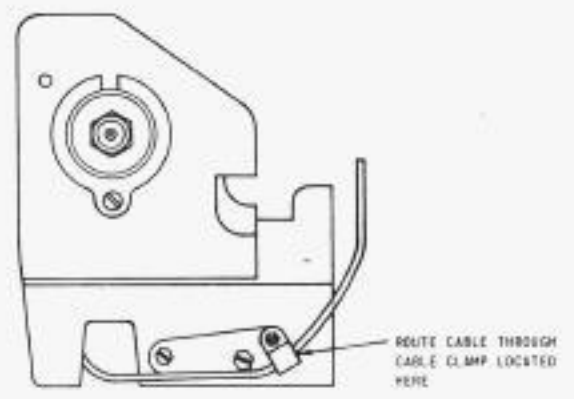
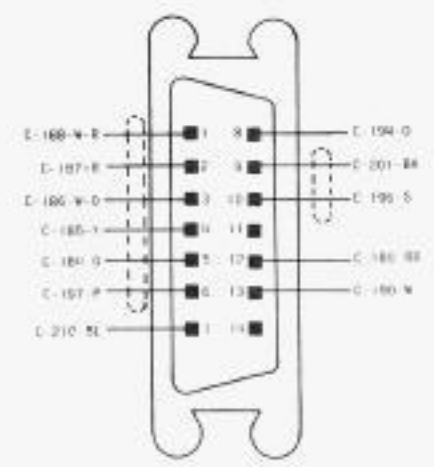

ACTUAL  
WIRING DIAGRAM  
FOR  
MODEL 28  
MULTIPLE WIRE  
DISTRIBUTOR  
LEDS

APPROVALS

D AND R      E OF M

E-NUMBER  
PROD. NO. 76029D

DATE 9-2-66

P.D. FILE NO. 21-465,210A

DRAWN D.D.S.      CHKD. TH  
ENGD. F.E.P.      APPD. RJS

TELETYPE CORPORATION

7842 WD