

REVISIONS		
ISSUE	DATE	AUTH. NO.
1	9-1-66	17734-R
2	1-30-67	92139
3	3-30-67	93209
4	4-9-67	94002
5	8-7-67	94301-B
6	10-25-67	94673-D
7	1-2-68	96486
8	4-24-69	98145
9	5-18-71	8722
10	3-3-72	4891
11	10-31-74	12093
12	6-23-77	18454

NOTE:
REVIEW BYWALDNER MUST ALSO BE
REFLECTED ON THE WIRE CONTROL AND
SRG WHICH IS A PART OF THIS DRAWING

1. WIRING LEGEND:
 DISTANT TERMINATING AREA
 DISTANT TERMINATING DESIGNATION
 C-20-BK (00-0) SEE NOTE 22
 WIRE COLOR CODE
2. COLOR CODE:
 W - WHITE P - PURPLE
 O - ORANGE G - GREEN
 Y - YELLOW R - RED
 BL - BLUE BK - BLACK
 BR - BROWN S - SLATE
3. UNITS WIRED FOR 60 CPS POWER INPUT ONLY.
4. RECEPTACLES VIEWED FROM WIRING SIDE.
5. * ASTERISK FOLLOWING WIRE COLOR INDICATES IN SR. WIRE.
6. ASSOCIATED CABLES:
 108205 - CABLE ASSEMBLY (WIRE POWER SUPPLY)
 319266 - CABLE ASSEMBLY (KEYBOARD)
 107022 - CABLE ASSEMBLY (PRINTER)
 319264 - CABLE ASSEMBLY (BASIC FACILITIES)
 312326 - CABLE ASSEMBLY (SIGNAL REGEN)
7. CONNECT EITHER LEAD OF THE SIGNAL BELL TO C-3G AND THE REMAINING LEAD TO C-5G AS INDICATED WHEN LESU IS INSTALLED.
8. ASSOCIATED WIRING DIAGRAMS & DRAWINGS:
 7072ND SCHEMATIC (VSL330, 331, 337 & 3RD)
 7074ND ACTUAL (CONTROL PANEL)
 7267ND ACTUAL (SEL. MAG. DRIVER)
 305489 DRAWING (SND CIRCUIT CARD)
 7794ND ACTUAL (SIGNAL REGENERATOR)
 7584ND ACTUAL (COPYLIGHT ASSEMBLY)
 312325 DRAWING (SIG. REGEN. CIRCUIT CARD)
9. NUMBERS SHOWN IN PARENTHESES ARE FOR REFERENCE ONLY AND ARE NOT MARKED ON COMPONENTS.
10. THE LES330D IS WIRED FOR 20 MA OPERATION (OPTION 2).
11. SET WIRED FOR HALF DUPLEX OPERATION FOR FULL DUPLEX OPERATION, REMOVE THE STRAP BETWEEN TERMINALS T6 AND T7 AND WIRE AS FOLLOWS:
- | RECEIVE LOOP | SEND LOOP |
|--------------|-----------|
| (+) T7 | (+) T5 |
| (-) T8 | (-) T6 |
12. LIVE-LOCAL OPTION 1 (L) OR (2) WIRE AS SHOWN FOR 20MA OPERATION (OPTION 2) FOR 60MA OPERATION (OPTION 3) MOVE THE BK-BL WIRE ON C-6G TO C-6C OR W-BK WIRE ON C-6C TO C-6B
13. ON REC -ONLY SETS, MOVE SRG-S-W-BK FROM C-5A TO C-3B AND MOVE E-4-R-S FROM C-3B TO C-5A
14. FOR 60MA OPERATION, THE 305489 CIRCUIT CARD MUST BE REPLACED BY THE 305446 CARD.
15. TAPE & TIE BACK TO MAIN CABLE BODY.
16. ELECTRICAL SERVICE UNIT WIRED FOR CURRENT SENSITIVE APPLICATIONS FOR VOLTAGE SENSITIVE (EIA INTERFACE) APPLICATIONS SEE NOTE 24.
17. REFERENCE SPECIFICATION FOR TELETYPE CORPORATION EMPLOYEES ONLY:
 61, 1068 (VSL330 & VSL331)
 61, 2168 (VSL330 & VSL340)
18. SL-BL INDICATES SLOW BLOWING

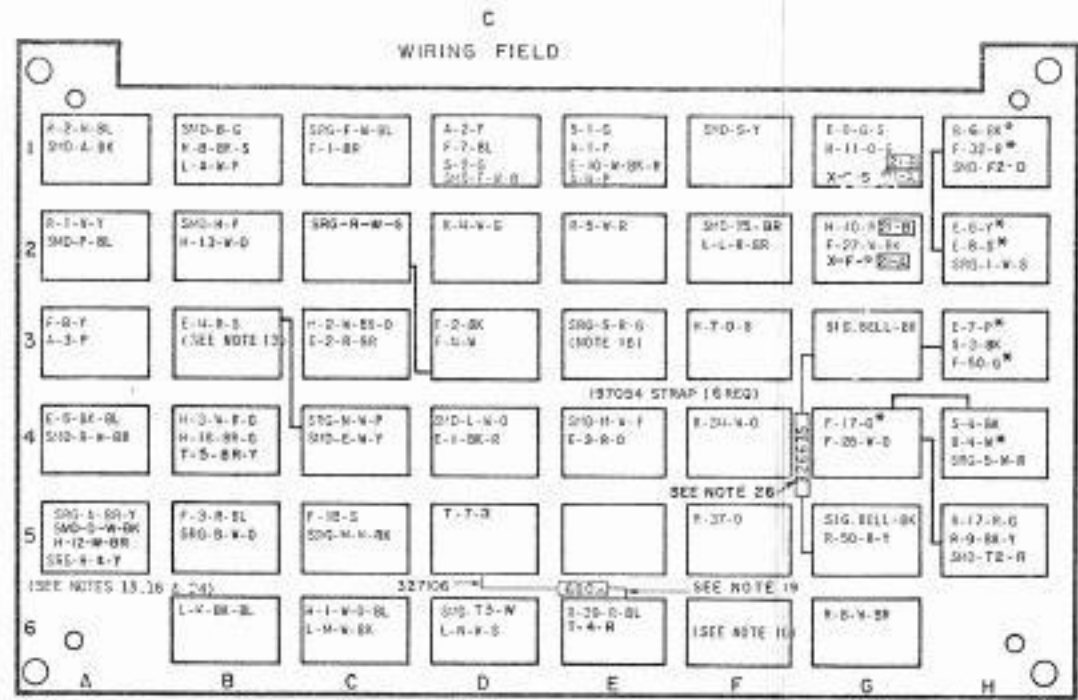

SIGNAL BELL
SEE NOTE 7

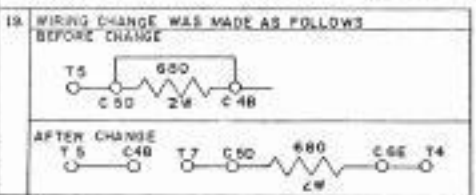
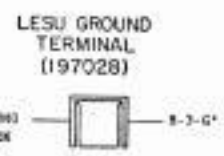
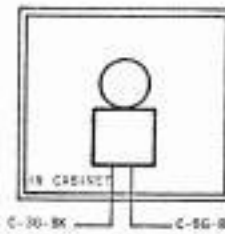

SRG SIGNAL REGENERATOR (305446)

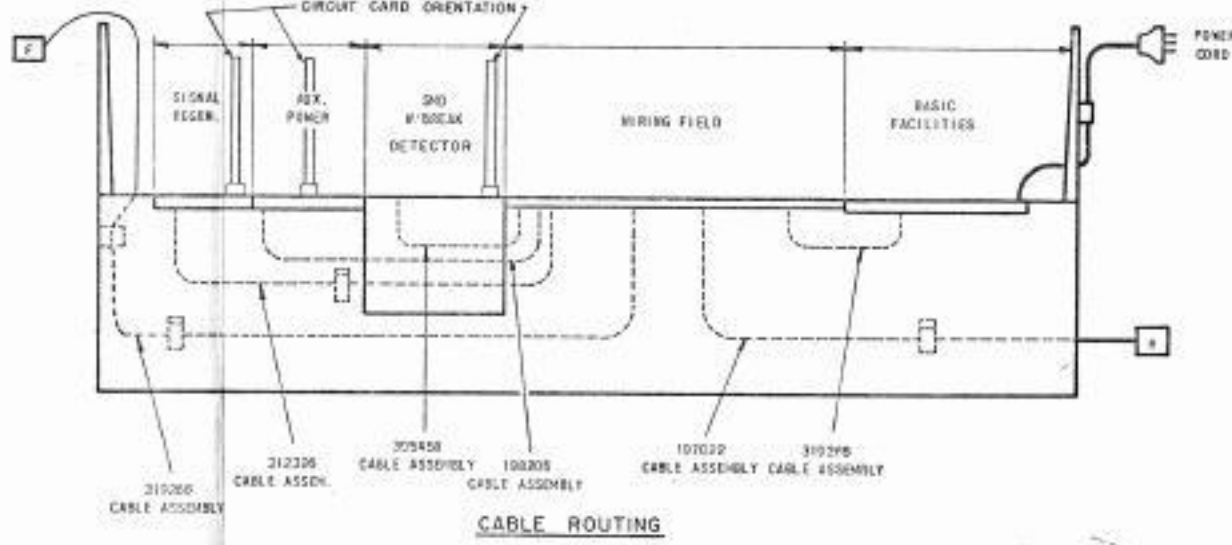
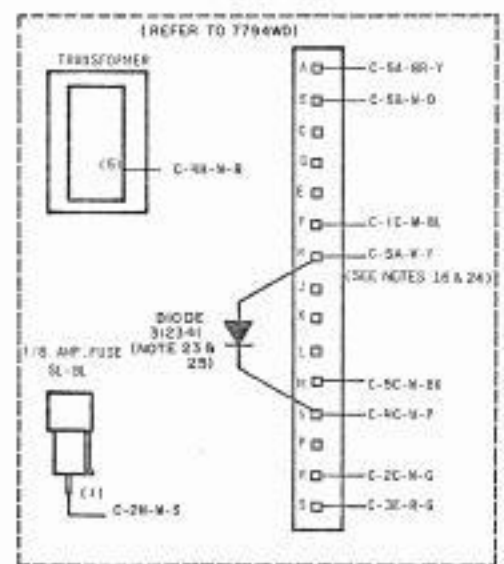

20. TO INTERFACE REGEN AUXILIARY DATA, SEE REMOVE METAL STRAP BETWEEN T6 AND T7. ADD (80)19 STRAP BETWEEN T6 AND T8.

INTERFACE REC. LOOP	SEND LOOP	COMMON
(+) T4	(+) T5	(-) T6

NOTES CONTINUED ON ISSUE CONTROL RECORD

SEE ISSUE CONTROL RECORD FOR COMPLETE LIST OF SHEETS COMPRISING THIS WD.

SHEET 1

ACTUAL WIRING DIAGRAM FOR LES330D ELECTRICAL SERVICE UNIT FOR MODEL 35 KEYBOARD (SEND-RECEIVE OR RECEIVE ONLY) PRIVATE LINE TELETYPE/TELETYPE SETS

APPROVALS

D AND R	E OF M
<i>[Signature]</i>	<i>[Signature]</i>

E-NUMBER
 PROD. NO. 797242
 DATE 12-22-65
 R.D. FILE NO. 1-8151.1116
 DRAWN R.T.S. CHD. *[Signature]*
 ENGR. R.L.M. APPD. *[Signature]*

TELETYPE CORPORATION
 7972 WD

REFER TO SHEET 1 FOR NOTES

**BASIC FACILITIES ASSEMBLY
(319257)**

NOTE: REVISION INFORMATION MUST ALSO
BE REFLECTED ON THE ISSUE
CONTROL RECORD, WHICH IS PART
OF THIS W.D.

7972 WD

REVISIONS

ISSUE	DATE	AUTH. NO.
1	9-1-66	17794-R
2	1-30-67	92138
3	9-29-67	94016
4	8-7-67	94501-B
5	10-25-67	94673-B
6	1-2-69	96495
7	10-31-74	12053

SMD

**LP SELECTOR MAGNET DRIVER
(305447)**

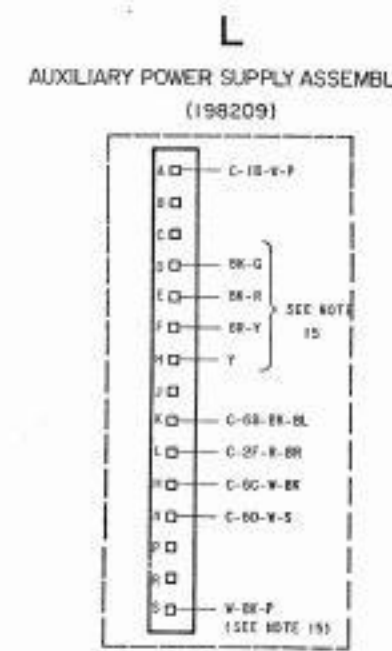
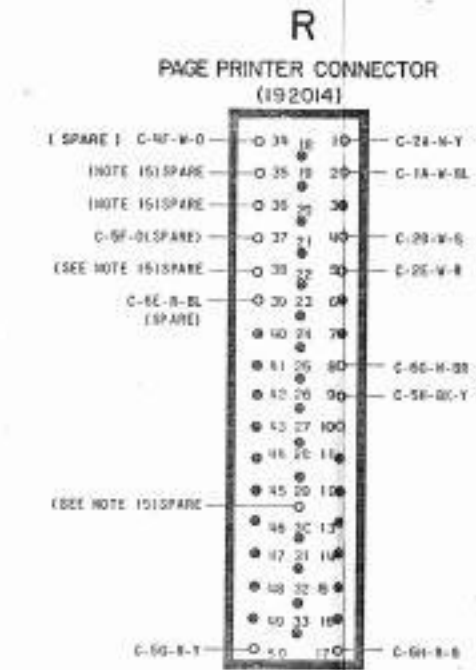
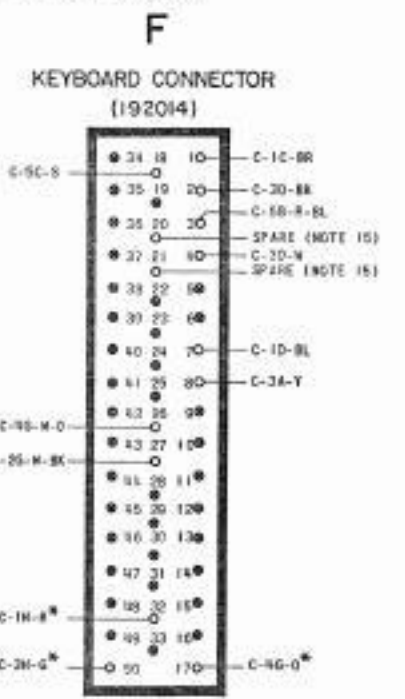
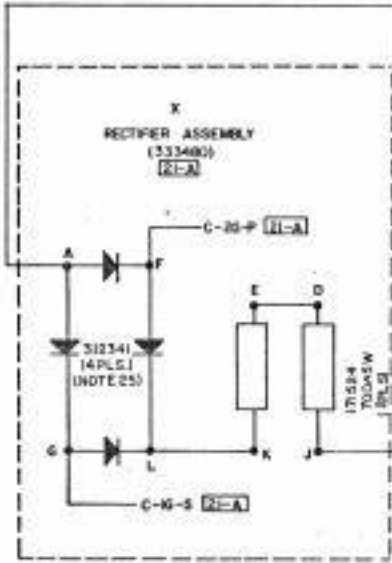
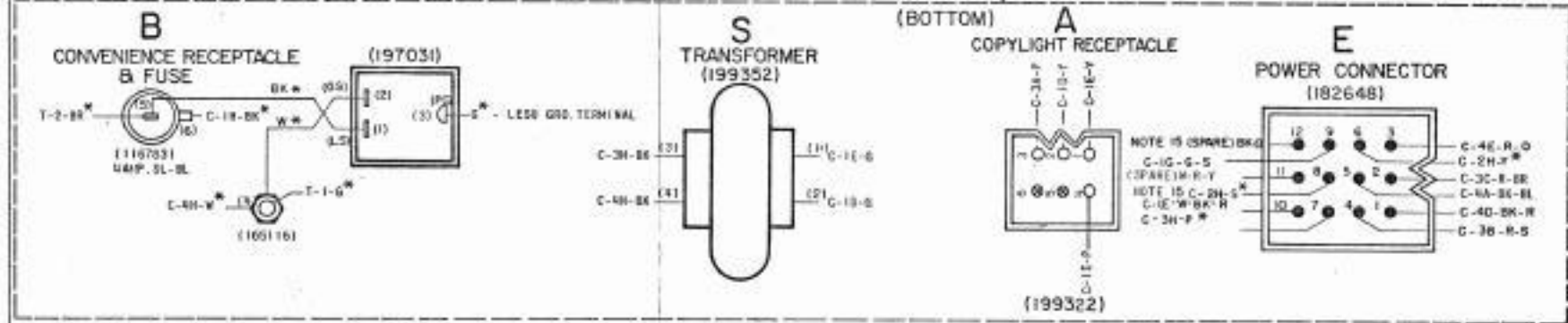
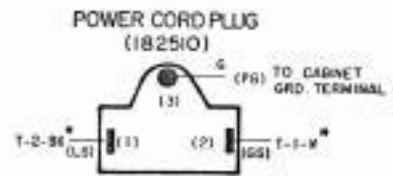
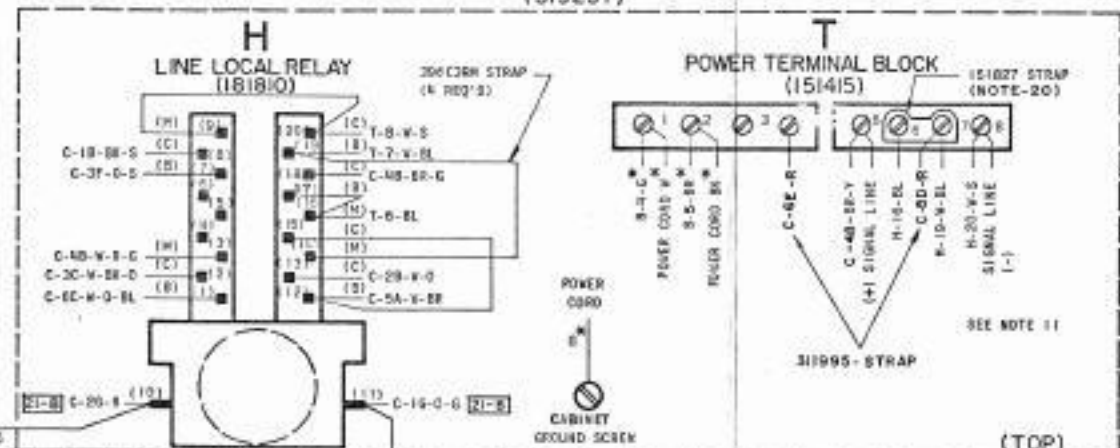
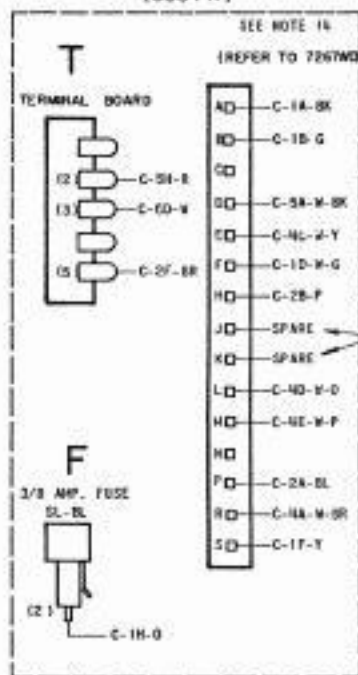

COVER TERMINAL WITH SUITABLE INSULATION (2 PLS.)

SEE ISSUE CONTROL RECORD FOR COMPLETE LIST OF SHEETS COMPRISING THIS W.D.

SHEET 2

ACTUAL WIRING DIAGRAM FOR LES839 ELECTRICAL SERVICE UNIT FOR MODEL 35 KEYBOARD SEND-RECEIVE OR RECEIVE-ONLY PRIVATE LINE TELETYPE UNIT SETS

APPROVALS

D AND R *AK* E OF M *LS*

E-NUMBER
PROD. NO. 7972WD
DATE 12-22-66
RD. FILE NO. 1-A151-A11C
DRAWN R.S. CHD. *Feb*
ENGD. P.L.V. APPD. *RRB*

TELETYPE CORPORATION

7972 WD